



VJS Vinyl Doors & Panels



WHY VJS JOINERY SUPPLIES

An industry pioneer, VJS Joinery Supplies has grown to become one of regional Australia's most innovative decorative surface manufacturers and distributors. We pride ourselves on our commitment to superior customer service, quality and providing the market with the broadest range of products. We have a mission to go the "extra mile" for all our customers. We are Your Trade Partner!

PEACE OF MIND

For the Australian market, VJS Joinery Supplies Doors are manufactured in Melbourne and carry a 7-year warranty.

TRUSTED BY THE INDUSTRY

We only supply you with the very best quality vacuum-formed doors and panels. VJS Vinyl is manufactured with precision and attention to every detail, thus offering you sophisticated styles using the highest moisture resistant E0 MDF and the most advanced gluing available.

ON-TREND DECORS

With an eye to the design community, we are always introducing new colours and patterns that complete VJS Joinery Supplies' well-rounded selection.

INNOVATIVE FINISHES

VJS Joinery Supplies features a variety of unique, decor enhancing surface finishes including Supermatt, Gloss, Texture, Satin and Grains & Textures.

VJS VINYL

Whether you prefer sleek and modern or sculpted and traditional, Vinyl Doors can bring a unique look to your space. Available in a wide range of decors and finishes, also in profile door styles.



CRAFTED IN AUSTRALIA

VJS Vinyl applies the perfect balance of cutting-edge manufacturing, with personalised attention to detail.



EASY TO CLEAN

Low maintenance surfaces that are simple to clean and maintain, making it easy to keep it looking newer for longer.



SEAMLESS EDGE DESIGN

Our wrap-around edge profile creates a luxurious, seamless look. No visible edgings.



APPLICATIONS

VJS Vinyl doors offer a durable surface that minimises the risk of chips and scratches for 'high traffic areas' - perfect for the way we live today.



DURABLE THERMO-LAMINATED DOORS

Suitable for vertical use, thermo-laminated doors are ideal for doors, drawers and panels in kitchens, pantries, bathrooms, laundries and wardrobes.

VJS VINYL 7 YEAR WARRANTY

The manufacturer warrants that VJS Vinyl thermo laminated and raw doors, drawers and panels shall be free from defect for a period of 7 years from the date of manufacture.

The manufacturer warrants that, under normal use and service, the material and workmanship of its products shall conform to the standards set forth on the applicable technical data sheets for a period of seven (7) years from the date of manufacture.

In the event that a VJS Vinyl product does not perform as warranted, the first purchaser's sole remedy shall be limited to repair or replacement of all or any part of the product which is defective, at the manufacturer's sole discretion.

This warranty applies only to product:

1. In its original installation; and
2. Purchased by the first consumer purchaser.

This warranty shall not apply to defects or damage arising from any of the following:

1. Accidents, abuse or misuse;
2. Exposure to extreme temperature;

3. Improper fabrication or installation; or
4. Improper maintenance.

Please note that if heat deflector strips are not used, the Warranty will be voided.

Heat deflector strips are designed to deflect the heat generated from flush mounted ovens and dishwashers away from the surrounding VJS Vinyl surfaces, ensuring added protection.

No other warranties, express or implied, are made. Under no circumstances shall the manufacturer be liable for any loss or damage arising from the purchase, use or inability to use this product, or for any special, indirect, incidental, or consequential damages. No fabricator, installer, dealer, agent or employee of VJS Joinery Supplies has the authority to modify the obligations or limitation of this warranty. The manufacturer warrants that VJS vinyl doors shall be free from defect for a period of 7 years from the date of manufacture. In the case of any damaged or missing items from a delivery, the customer is to make a report within 5 working days.





Battalion S

Branco S

NEUTRALS AND COLOURS

Featuring classic and timeless colours, adaptable neutrals and greys, our solids collection incorporates simple basics with stand-out colours. This collection provides a versatile base to choose from, whether pairing with existing colours, patterns or woods, or designing a unique colour story for any project.

FINISHES:

Decors are stocked in selected finishes that emphasise their design.

S **Satin** T **Texture** M **Matt** GL **Gloss** GT **Grains & Textures** SM **Supermatt**

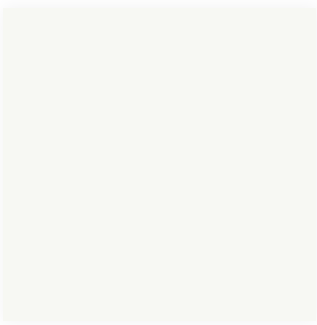

Branco

S M GL



Drafted White

S GL

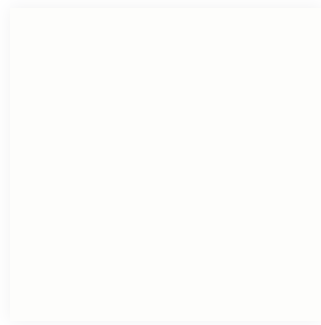

White Lux

S GL T



Lantern

S GL

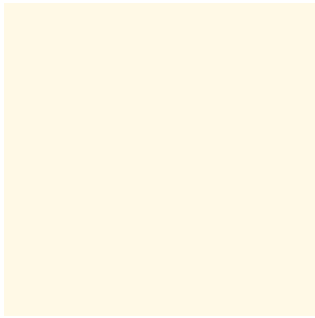

New Antique White (S) (GL)

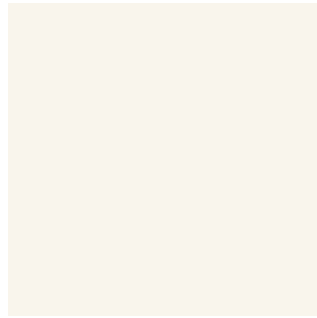

Alabastino (S) (GL)



Vongole (SM)

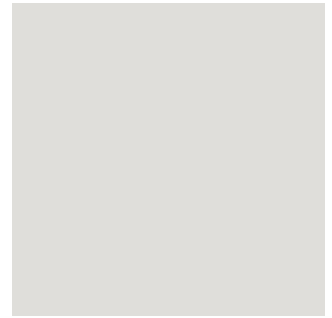

Royal Oyster (S) (GL)

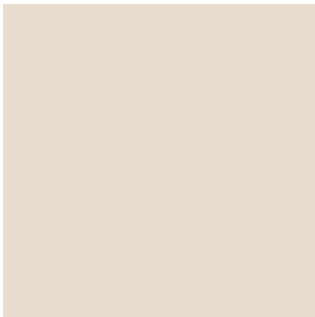

Linen (SM)



Darkar (SM)

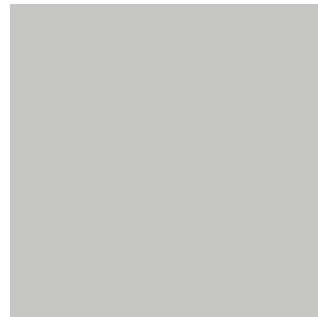

Clamshell (S) (SM)

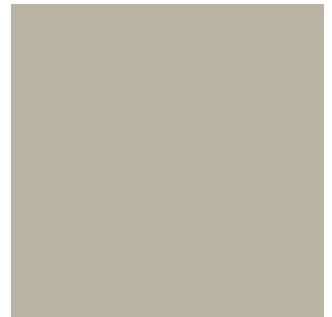

Marina Grey (SM)



Peltro (SM)



Tobacco (GL)



Denim (M)

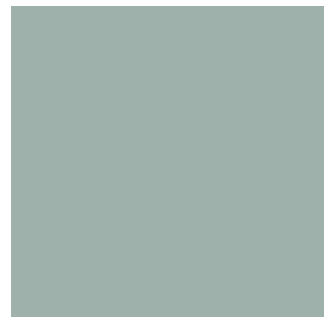

Fjord (M)



Alcove (SM)



Bayleaf (SM)



Ink (T)

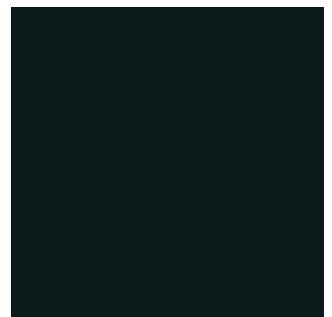

Battalion (S)



Night (T)



Seed Black (SM)

Colours in this brochure are representations only and may vary slightly from the actual product. A true and reliable colour match is only possible with a sample, available free from your nearest VJS Branch or by calling 1300 842 577.



TIMBER GRAINS

With a combination of realistic and wood-inspired designs these curated, organic patterns provide the opportunity to appreciate rare and endangered wood in a sustainable way; or choose from classic, traditional wood patterns for use in a wide variety of applications. Coupled with the seamless edge of vinyl, these woodgrain designs emulate natural timber doors.



Drafted White

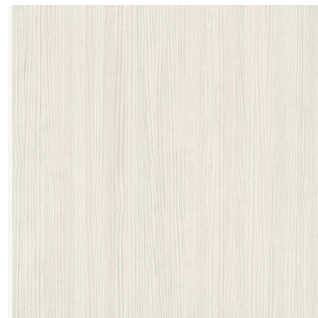

Linea Wood Light



Halo Oak



Original Oak



Burleigh Oak



Sombra Grove



Linea Wood Dark



Colours in this brochure are representations only and may vary slightly from the actual product. A true and reliable colour match is only possible with a sample, available free from your nearest VJS Branch or by calling 1300 842 577.

DOOR STYLES

COLLECTION 1 (C1)

Classic

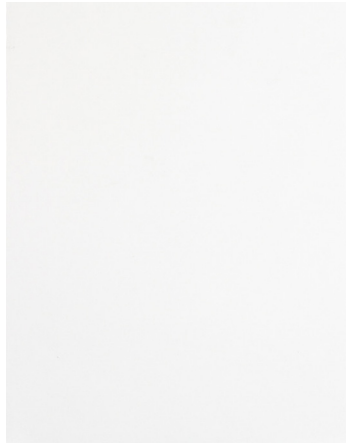

C1: Lorne



C1: Montreal

COLLECTION 2 (C2)

Handle-less & Soft Profile

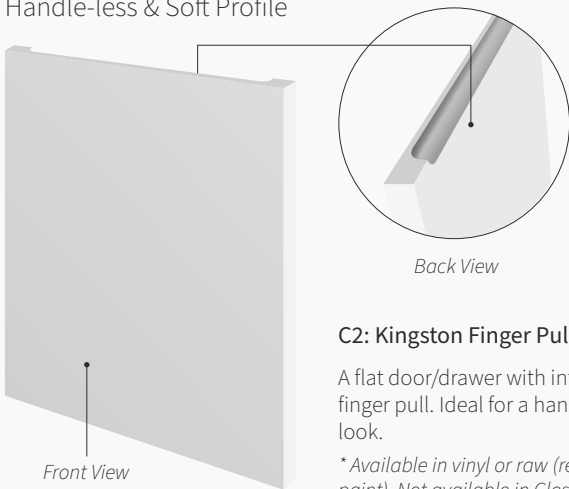

C2: Kingston Finger Pull

A flat door/drawer with integrated finger pull. Ideal for a handle-less look.

* Available in vinyl or raw (ready for paint). Not available in Gloss (GL) finish.

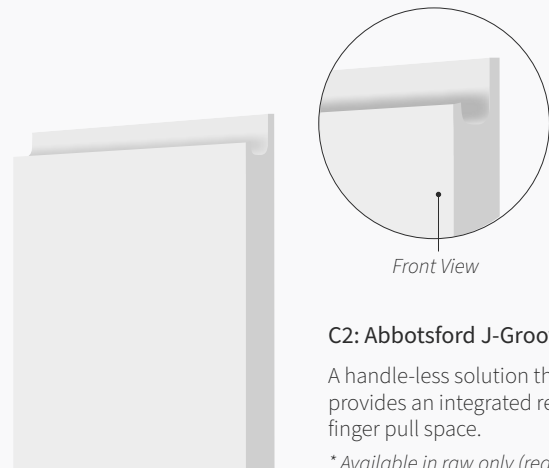

C2: Abbotsford J-Groove

A handle-less solution that provides an integrated reverse finger pull space.

* Available in raw only (ready for paint).

L-SHAPE AND C-SHAPE RECESSED RAILS

Recessed rails are used instead of handles and integrated into your cabinet design. They are placed behind the drawers or doors, allowing finger space to open doors and provide a streamlined design.

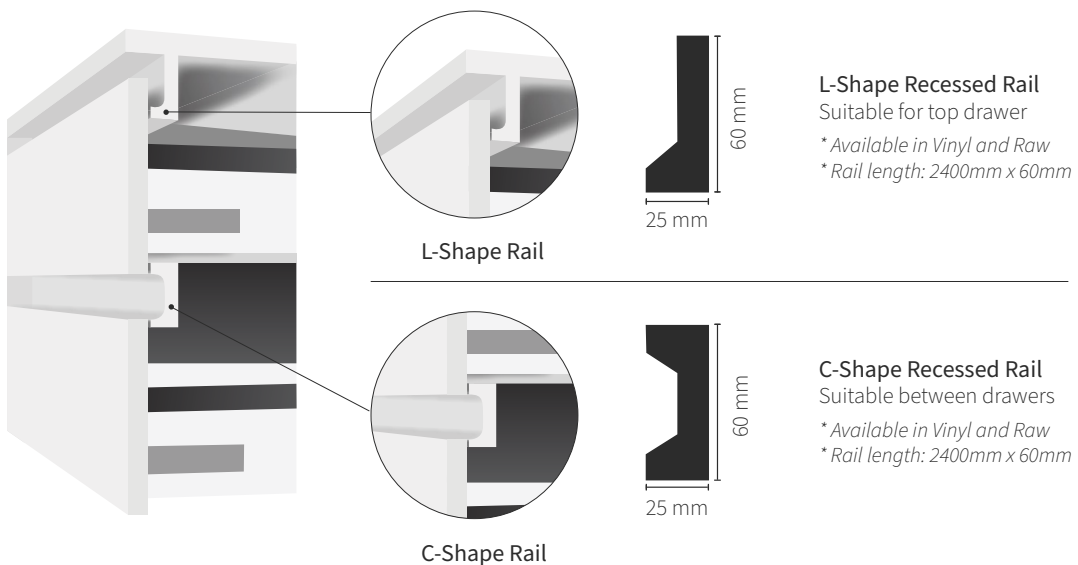

COLLECTION 2 (C2)



C2: Edmonton

COLLECTION 3 (C3)

Sharp Profile



C3: Duncan

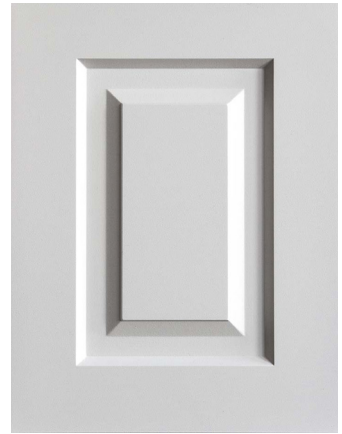

C3: Laval*

** Optional: with groove rails.*



C3: London

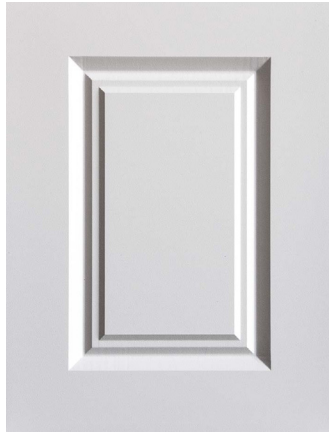

C3: Nelson



C3: Surrey

COLLECTION 4 (C4)

Recessed Panel & V Groove



C4: Barrie*

** Not available in Gloss (GL) finish.*

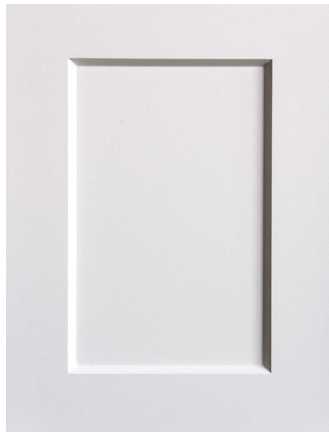

C4: Cambridge*

** 6mm depth shown.*

** 3mm also available.*

** Not available in Gloss (GL) finish.*



C4: Cambridge 20*

** Available in 3mm depth only.*

** Not available in Gloss (GL) finish.*

COLLECTION 4 (C4):

Recessed Panel & V Groove



C4: Cambridge 10*

** Available in 3mm depth only. *
Not available in Gloss (GL) finish.*

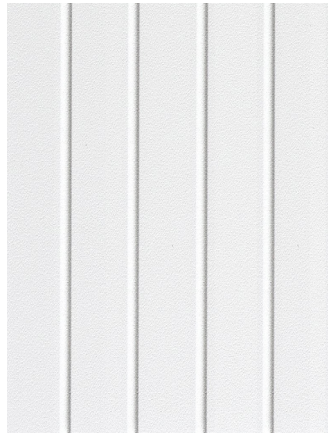

C4: Halifax*

** 60mm spacing shown.
* Custom spacing can be ordered.*



C4: Saint John*

** 30mm spacing shown.
* Custom spacing can be ordered.*

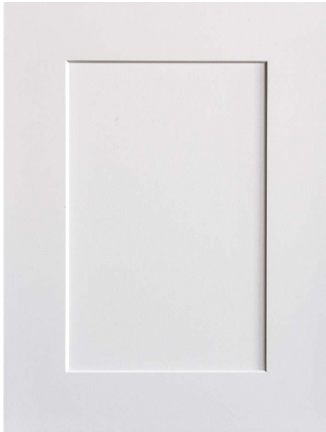

C4: Somerton*

** Not available in Gloss (GL) finish.*



C4: Somerton 20*

** Available in 3mm depth only.
* Not available in Gloss (GL) finish.*



C4: Somerton 10*

** Available in 3mm depth only.
* Not available in Gloss (GL) finish.*

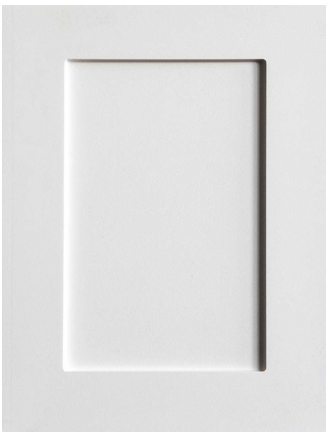

C4: Victoria*

** 6mm depth shown.
* 3mm also available.
* Only available as a raw door.*



C4: Windsor*

** 90mm spacing shown.
* Custom spacing can be ordered.*

COLLECTION 5 (C5):

Recessed Panel with detailed profile



C5: Ontario*

** Not available in Gloss (GL) finish.*

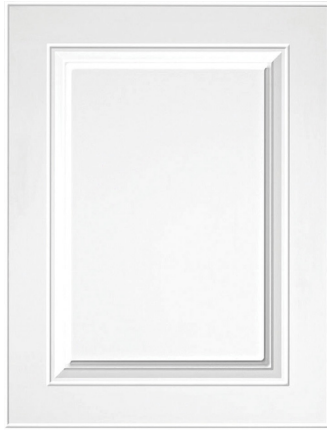

C5: Oxford*

** Not available in Gloss (GL) finish.*

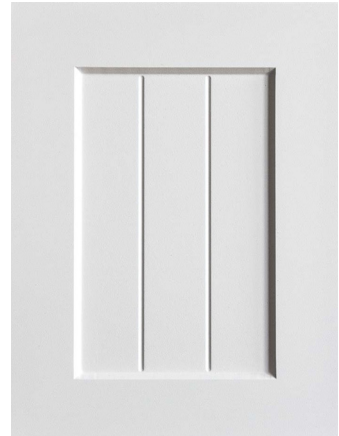

C5: Richmond*

** Not available in Gloss (GL) finish.*



C5: Toronto*

** Not available in Gloss (GL) finish.*



C5: Toronto - no rails*

** Not available in Gloss (GL) finish.*



C5: Vernon*

** Not available in Gloss (GL) finish.*

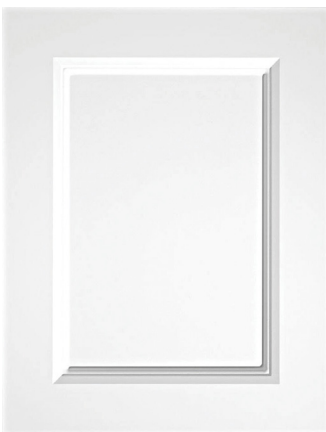

C5: Winchester

** Not available in Gloss (GL) finish.*

VINYL FINISHES

VJS features a variety of different surface finishes across a wide range of decors – Gloss, Matt, Satin and Supermatt as well as organic wood grain & unique textured finishes. These finishes will add another dimension to your surface and create endless design possibilities, along with high performance.



This texture group is a dense structure with a moderate reflective and soft tactile quality.



This woodgrain and texture group is a low sheen finish with dimensional textures and natural timber variation.



This texture group has a low reflective finish quality.



This texture group is a low sheen finish with a super smooth feel, complimenting both solid colours and timber grains.



A mirror sheen finish with brilliant appearance.



This texture group is a subtle tactile touch with a moderate reflective grain sheen level.

Textures shown in this brochure are representations only and may vary slightly from the actual product. For all finishes, please refer to sample for specific texture, available free from your nearest VJS Branch or by calling 1300 842 577.



DOOR STYLE AVAILABILITY

COLLECTION	DOOR STYLE	VINYL			RAW (paint ready)		
		AVAILABLE	MIN. SIZE	MAX. SIZE	AVAILABLE	MIN. SIZE	MAX. SIZE
Collection 1 (C1)	Lorne	●	60x250mm	1200x2500mm	●	60x250mm	1200x3000mm
	Montreal	●	60x250mm	1200x2500mm	●	60x250mm	1200x3000mm
Collection 2 (C2)	Abbotsford				●	80x250mm	1200x3000mm
	Edmonton	●	170mmx170mm	1200x2500mm	●	170x170mm	1200x3000mm
	Kingston	No Gloss	80mmx180mm	1200x2500mm	●	80x180mm	1200x3000mm
Collection 3 (C3)	Duncan	●	215x215mm	1200x2500mm	●	215x215mm	1200x3000mm
	Laval	●	215x215mm	1200x2500mm	●	215x215mm	1200x3000mm
	London	●	220x220mm	1200x2500mm	●	220x220mm	1200x3000mm
	Nelson	●	215x215mm	1200x2500mm	●	215x215mm	1200x3000mm
	Surrey	●	215x215mm	1200x2500mm	●	215x215mm	1200x3000mm
Collection 4 (C4)	Barrie	No Gloss	170x170mm	1200x2500mm	●	170x170mm	1200x3000mm
	Cambridge	No Gloss	170x170mm	1200x2500mm	●	170x170mm	1200x3000mm
	Cambridge 20	No Gloss	90x90mm	1200x2500mm	●	90x90mm	1200x3000mm
	Cambridge 10	No Gloss	70x70mm	1200x2500mm	●	70x70mm	1200x3000mm
	Halifax	●	80x250mm	1200x2500mm	●	80x250mm	1200x3000mm
	Saint John	●	80x250mm	1200x2500mm	●	80x250mm	1200x3000mm
	Somerton	No Gloss	170x170mm	1200x2500mm	●	170x170mm	1200x3000mm
	Somerton 20	No Gloss	90x90mm	1200x2500mm	●	90x90mm	1200x3000mm
	Somerton 10	No Gloss	70x70mm	1200x2500mm	●	70x70mm	1200x3000mm
	Victoria				●	170x170mm	1200x3000mm
Windsor	●	80x250mm	1200x2500mm	●	250x80mm	1200x3000mm	
Collection 5 (C5)	Ontario	No Gloss	200x200mm	1200x2500mm	●	200x200mm	300x2400mm
	Oxford	No Gloss	200x200mm	1200x2500mm	●	200x200mm	1200x3000mm
	Richmond	No Gloss	170x170mm	1200x2500mm	●	170x170mm	1200x3000mm
	Toronto	No Gloss	200x200mm	1200x2500mm	●	200x200mm	1200x3000mm
	Toronto - no rails	No Gloss	200x200mm	1200x2500mm	●	200x200mm	1200x3000mm
	Vernon	No Gloss	170x170mm	1200x2500mm	●	170x170mm	1200x3000mm
	Winchester	No Gloss	200x200mm	1200x2500mm	●	200x200mm	1200x3000mm
Flutes & Rosettes	Brant	●	100x500mm	300x2400mm	●	100x500mm	300x2400mm
	Elliot	●	100x500mm	300x2400mm	●	100x500mm	300x2400mm
	Lynn	●	100x500mm	300x2400mm	●	100x500mm	300x2400mm
	Mirabel	●	100x500mm	300x2400mm	●	100x500mm	300x2400mm
	Rosette	●	100x100mm	100x100mm	●	100x100mm	100x100mm

Standard thickness is 18mm. Thicknesses up to 25mm can also be done, POA.

Minimum sizing relates to minimum individual panel size based on rail width of door style. Sizing can be smaller for individual drawers depending on heights and drawer configuration. Refer to page 15 for more detail.

DOOR ACCESSORIES

DECORATIVE FLUTES

100mm width standard

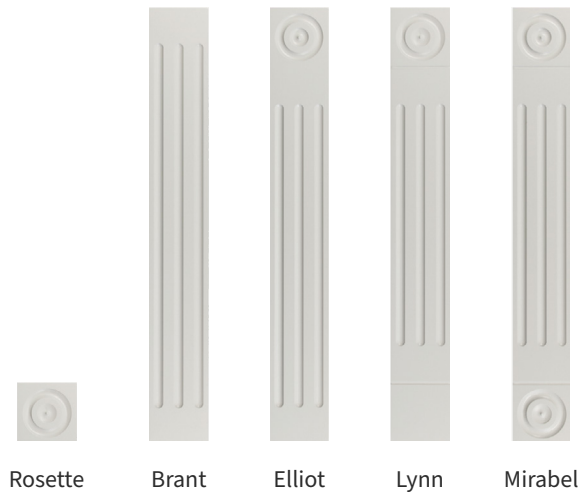

DOOR EDGE PROFILES

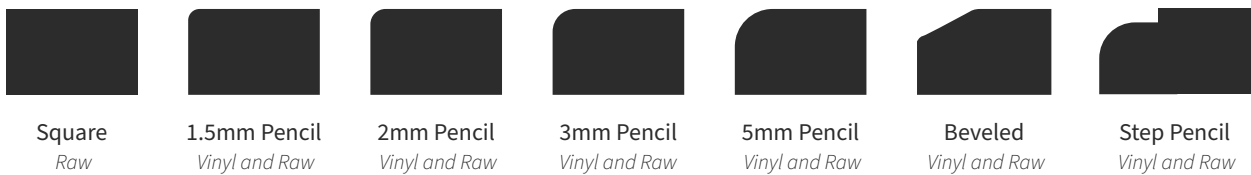

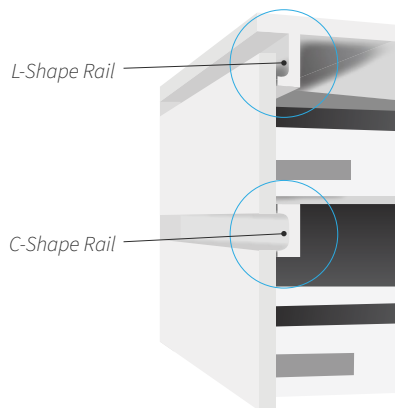

RECESSED RAILS & DECORATIVE CAPPING

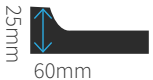

ACCESSORIES

Recessed Rails & Cap Moulding

Style Options	Dimensions	Available Finish
C Shape Recessed Rail	2400 X 60mm X 25mm 	Vinyl and Raw
L Shape Recessed Rail	2400 X 60mm X 25mm 	Vinyl and Raw
Cap Moulding	2400 X 90mm X 32mm 	Vinyl and Raw

ADDITIONAL STYLE OPTIONS FOR VINYL & RAW

GLASS FRAMES

Each glass frame is rebated to allow for glass to be fitted.

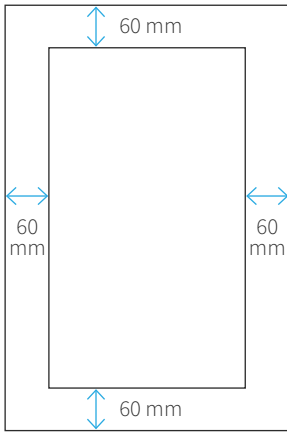

Single Frame

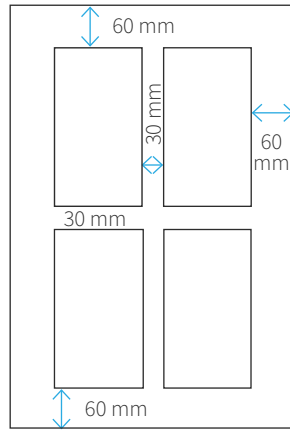

Colonel Style
4, 6, 8 or 12 Windows

DRAWERS

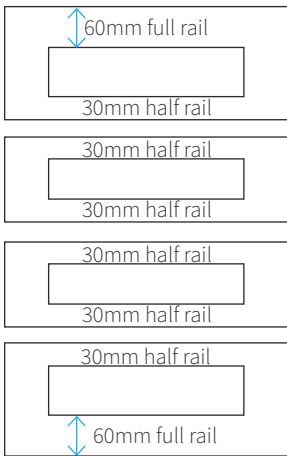

Individual Drawers

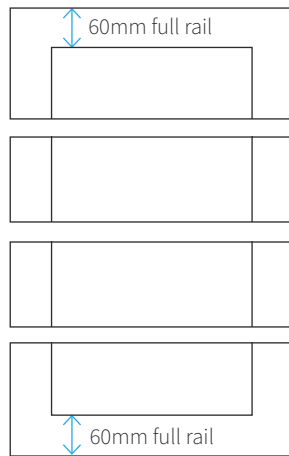

Drawer Bank
** Cut from a Single Door*

BAR PANELS

Up to 5 profiles per panel.

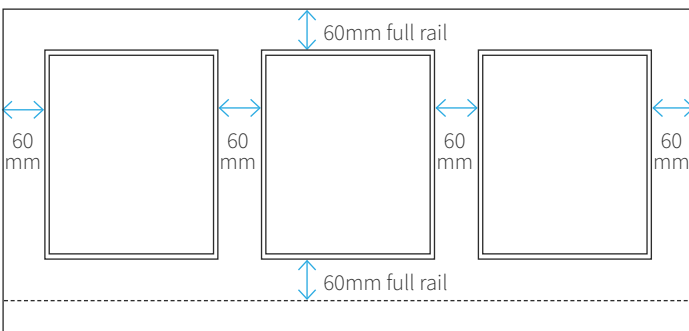

PANTRY DOORS

Standard Chair Rail is 60mm. Double Chair Rail available (120mm).

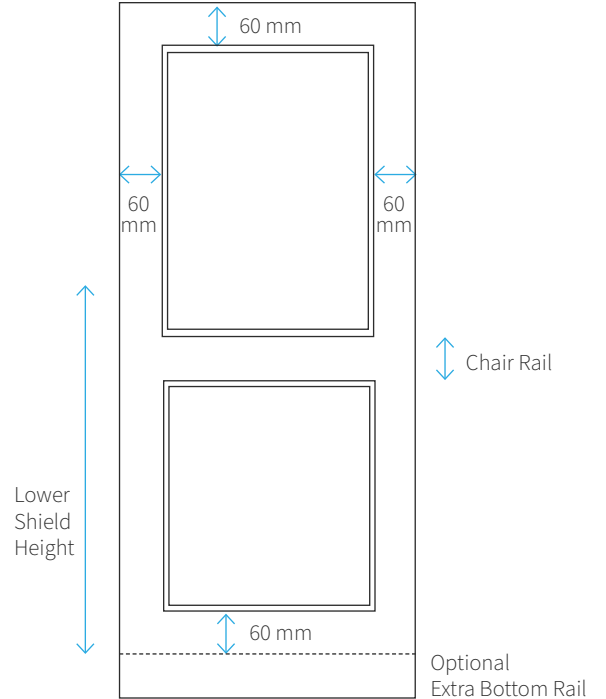

MICROWAVE SURROUNDS

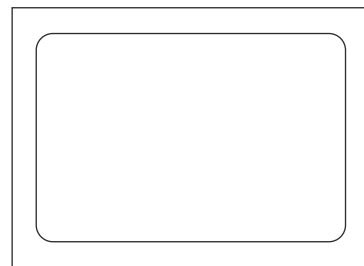

ROLLER SHUTTER DOOR SURROUND PANEL

125mm minimum internal height & width.
Carcase side thickness - 40mm suits handle on roller shutter.

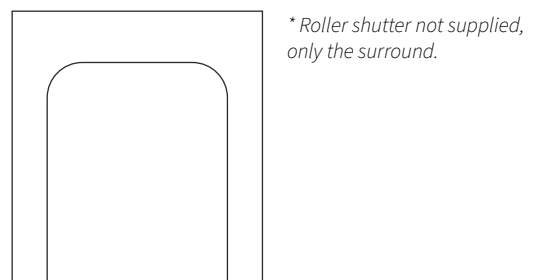

** Roller shutter not supplied, only the surround.*

Optional
Extra Bottom Rail



GEELONG BRANCH
76-78 Barwon Terrace,
South Geelong VIC 3220
sales@vjsjs.com.au

MILDURA BRANCH
335 Benetook Ave
Mildura VIC 3500
sales.mildura@vjsjs.com.au

SHEPPARTON BRANCH
5-7 Callister Street,
Shepparton VIC 3630
sales.shep@vjsjs.com.au

VJS JOINERY SUPPLIES

1300 842 577 • www.vjsjs.com.au

ALBURY BRANCH
61 Fallon Street,
East Albury NSW 2640
sales.albury@vjsjs.com.au

WAGGA WAGGA BRANCH
13 Riedell Street,
East Wagga Wagga NSW 2650
sales.wagga@vjsjs.com.au

